

C0304 Flareless Cap

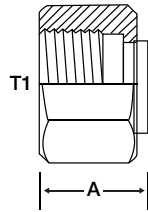

Part Number	T1
C0304-02	1/8
C0304-04	1/4
C0304-06	3/8
C0304-08	1/2
C0304-10	5/8
C0304-12	3/4
C0304-16	1
C0304-20	1 1/4

C0306 Flareless Locknut

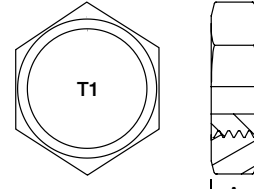

Part Number	T1
C0306-04	1/4
C0306-06	3/8
C0306-08	1/2
C0306-10	5/8
C0306-12	3/4
C0306-16	1
C0306-20	1 1/4

C0318 Flareless Nut

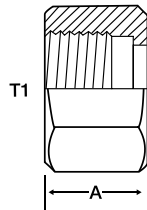

Part Number	T1
C0318-02	1/8
C0318-03	3/16
C0318-04	1/4
C0318-05	5/16
C0318-06	3/8
C0318-08	1/2
C0318-10	5/8
C0318-12	3/4
C0318-16	1
C0318-20	1 1/4
C0318-24	1 1/2
C0318-32	2

C0319 Flareless Sleeve

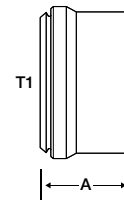

Part Number	T1
C0319-02	1/8
C0319-03	3/16
C0319-04	1/4
C0319-05	5/16
C0319-06	3/8
C0319-08	1/2
C0319-10	5/8
C0319-12	3/4
C0319-16	1
C0319-20	1 1/4
C0319-24	1 1/2
C0319-32	2

BECAUSE WE CONTINUALLY EXAMINE WAYS TO IMPROVE OUR PRODUCTS, WE RESERVE THE RIGHT TO ALTER SPECIFICATIONS WITHOUT NOTICE.

Flareless Compression

C2402 FC - MJ

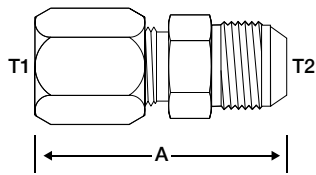

Part Number	T1	T2
	FC	MJ
C2402-0404	1/4	7/16 - 20
C2402-0606	3/8	9/16 - 18
C2402-0808	1/2	3/4 - 16
C2402-1010	5/8	7/8 - 14
C2402-1212	3/4	1 1/16 - 12
C2402-1616	1	1 5/16 - 12
C2402-2020	1 1/4	1 5/8 - 12

C2404 FC - MP

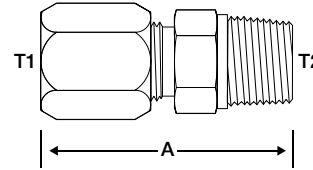

Part Number	T1	T2
	FC	MNPT
C2404-0202	1/8	1/8 - 27
C2404-0204	1/8	1/4 - 18
C2404-0302	3/16	1/8 - 27
C2404-0402	1/4	1/8 - 27
C2404-0404	1/4	1/4 - 18
C2404-0406	1/4	3/8 - 18
C2404-0408	1/4	1/2 - 14
C2404-0502	5/16	1/8 - 27
C2404-0504	5/16	1/4 - 18
C2404-0602	3/8	1/4 - 18
C2404-0604	3/8	1/8 - 27
C2404-0606	3/8	3/8 - 18
C2404-0608	3/8	1/2 - 14
C2404-0804	1/2	3/8 - 18
C2404-0806	1/2	1/4 - 18
C2404-0808	1/2	1/2 - 14
C2404-0812	1/2	3/4 - 14
C2404-1006	5/8	1/2 - 14
C2404-1008	5/8	3/8 - 18
C2404-1208	3/4	3/4 - 14
C2404-1212	3/4	1/2 - 14
C2404-1412	7/8	3/4 - 14
C2404-1612	1	1 - 11 1/2
C2404-1616	1	3/4 - 14
C2404-2020	1 1/4	1 1/4 - 11 1/2
C2404-2424	1 1/2	1 1/2 - 11 1/2
C2404-3232	2	2 - 11 1/2

C2403 FC - FC

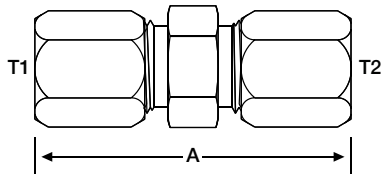

Part Number	T1	T2
	FC	FC
C2403-0202	1/8	1/8
C2403-0303	3/16	3/16
C2403-0404	1/4	1/4
C2403-0505	5/16	5/16
C2403-0604	3/8	1/4
C2403-0606	3/8	3/8
C2403-0808	1/2	1/2
C2403-1010	5/8	5/8
C2403-1212	3/4	3/4
C2403-1414	7/8	7/8
C2403-1616	1	1
C2403-2020	1 1/4	1 1/4
C2403-2424	1 1/2	1 1/2
C2403-3232	2	2

BECAUSE WE CONTINUALLY EXAMINE WAYS TO IMPROVE OUR PRODUCTS, WE RESERVE THE RIGHT TO ALTER SPECIFICATIONS WITHOUT NOTICE.

C2405 FC - FP

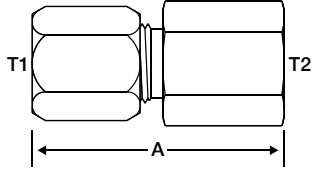

Part Number	T1	T2
	FC	FNPT
C2405-0202	1/8	1/8 - 27
C2405-0402	1/4	1/8 - 27
C2405-0404	1/4	1/4 - 18
C2405-0502	5/16	1/8 - 27
C2405-0604	3/8	1/4 - 18
C2405-0606	3/8	3/8 - 18
C2405-0806	1/2	3/8 - 18
C2405-0804	1/2	1/4 - 18
C2405-0808	1/2	1/2 - 14
C2405-1008	5/8	1/2 - 14
C2405-1212	3/4	3/4 - 14
C2405-1616	1	1 - 11 1/2
C2405-2020	1 1/4	1 1/4 - 11 1/2

C2406 Stand Pipe - FC

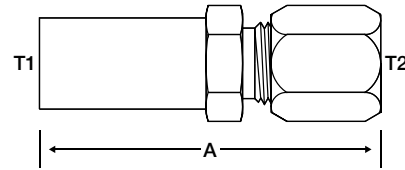

Part Number	T1	T2
	SP	FC
C2406-0604	3/8	1/4
C2406-0804	1/2	1/4
C2406-0806	1/2	3/8
C2406-1008	5/8	1/2
C2406-1208	3/4	1/2
C2406-1612	1	3/4
C2406-2016	1 1/4	1

C2408 Flareless - Plug

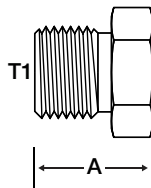

Part Number	T1
	FC
C2408-02	1/8
C2408-04	1/4
C2408-05	5/16
C2408-06	3/8
C2408-08	1/2
C2408-10	5/8
C2408-12	3/4
C2408-16	1

C2500 FC - FC 90°

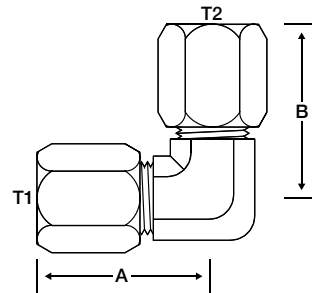

Part Number	T1	T2
	FC	FC
C2500-0404	1/4	1/4
C2500-0505	5/16	5/16
C2500-0606	3/8	3/8
C2500-0808	1/2	1/2
C2500-1010	5/8	5/8
C2500-1212	3/4	3/4
C2500-1616	1	1
C2500-2020	1 1/4	1 1/4
C2500-2424	1 1/2	1 1/2

Flareless Compression

C2501 FC - MP 90°

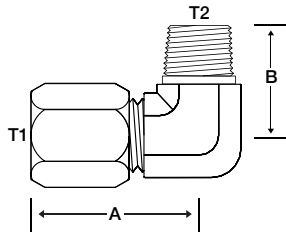

C2503 FC - MP 45°

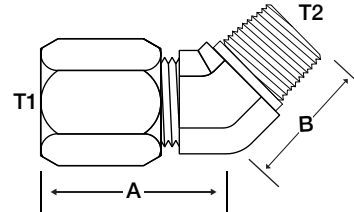

Part Number	T1	T2
	FC	MNPT
C2501-0202	1/8	1/8 - 27
C2501-0302	3/16	1/8 - 27
C2501-0402	1/4	1/8 - 27
C2501-0404	1/4	1/4 - 18
C2501-0502	5/16	1/8 - 27
C2501-0504	5/16	1/4 - 18
C2501-0602	3/8	1/4 - 18
C2501-0604	3/8	1/8 - 27
C2501-0606	3/8	3/8 - 18
C2501-0608	3/8	1/2 - 14
C2501-0806	1/2	3/8 - 18
C2501-0804	1/2	1/4 - 18
C2501-0808	1/2	1/2 - 14
C2501-1008	5/8	1/2 - 14
C2501-1006	5/8	3/8 - 18
C2501-1212	3/4	3/4 - 14
C2501-1208	3/4	1/2 - 14
C2501-1412	7/8	3/4 - 14
C2501-1616	1	1 - 11 1/2
C2501-1612	1	3/4 - 14
C2501-2020	1 1/4	1 1/4 - 11 1/2
C2501-2424	1 1/2	1 1/2 - 11 1/2
C2501-3232	2	2 - 11 1/2

Part Number	T1	T2
	FC	MNPT
C2503-0402	1/4	1/8 - 27
C2503-0404	1/4	1/4 - 18
C2503-0502	5/16	1/8 - 27
C2503-0604	3/8	1/4 - 18
C2503-0806	1/2	3/8 - 18
C2503-0808	1/2	1/2 - 14
C2503-1008	5/8	1/2 - 14
C2503-1212	3/4	3/4 - 14
C2503-1616	1	1 - 11 1/2

C2601 FC - FC - MP Tee

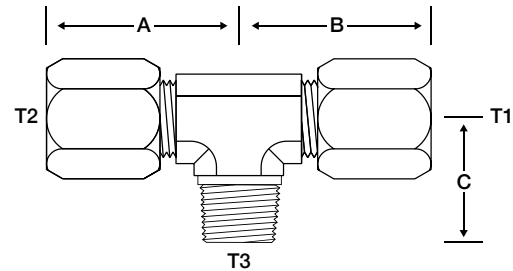

Part Number	T1 / T2	T3
	FC	MNPT
C2601-040402	1/4	1/8 - 27
C2601-040404	1/4	1/4 - 18
C2601-050502	5/16	1/8 - 27
C2601-060604	3/8	1/4 - 18
C2601-080806	1/2	3/8 - 18
C2601-080808	1/2	1/2 - 14
C2601-101008	5/8	1/2 - 14
C2601-121212	3/4	3/4 - 14
C2601-161616	1	1 - 11 1/2

BECAUSE WE CONTINUALLY EXAMINE WAYS TO IMPROVE OUR PRODUCTS, WE RESERVE THE RIGHT TO ALTER SPECIFICATIONS WITHOUT NOTICE.

C2602 FC - FC - FP Tee

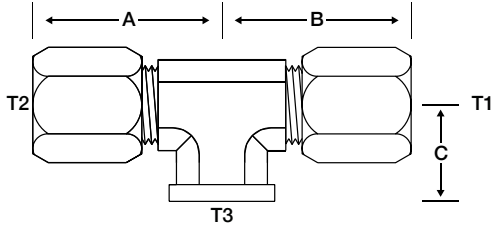

Part Number	T1 / T2	T3
	FC	FNPT
C2602-040402	1/4	1/8 - 27
C2602-040404	1/4	1/4 - 18
C2602-060604	3/8	1/4 - 18
C2602-080806	1/2	3/8 - 18
C2602-080808	1/2	3/4 - 16
C2602-101008	5/8	1/2 - 14
C2602-121212	3/4	3/4 - 14
C2602-161616	1	1 - 11 1/2
C2602-202020	1 1/4	1 1/4 - 11 1/2

C2603 FC - FC - FC Tee

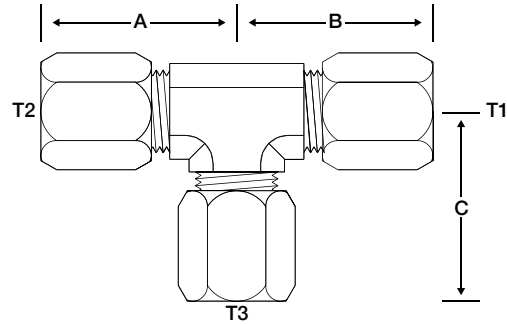

Part Number	T1 / T2	T3
	FC	FC
C2603-040404	1/4	1/4
C2603-050505	5/16	5/16
C2603-060606	3/8	3/8
C2603-080806	1/2	1/2
C2603-080808	1/2	1/2
C2603-101010	5/8	5/8
C2603-121212	3/4	3/4
C2603-161616	1	1
C2603-202020	1 1/4	1 1/4

Flareless Compression

C2605 FC - MP - FC Tee

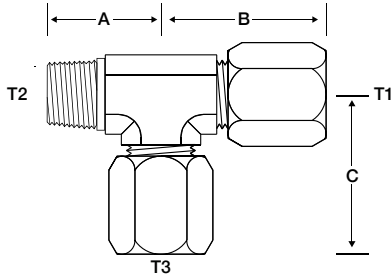

C2606 FC - FP - FC Tee

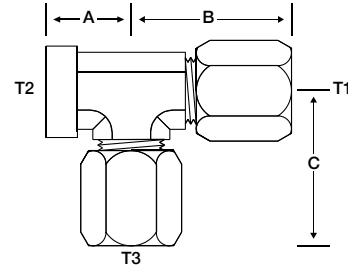

Part Number	T1 / T3	T2
	FC	MNPT
C2605-040404	1/4	1/4 - 18
C2605-050205	5/16	1/8 - 27
C2605-060406	3/8	1/4 - 18
C2605-060606	3/8	3/8 - 18
C2605-080608	1/2	3/8 - 18
C2605-080808	1/2	1/2 - 14
C2605-100810	5/8	1/2 - 14
C2605-121212	3/4	3/4 - 14
C2605-161616	1	1 - 11 1/2

Part Number	T1 / T3	T2
	FC	FNPT
C2606-040404	1/4	1/4 - 18
C2606-060406	3/8	1/4 - 18
C2606-080608	1/2	3/8 - 18
C2606-100810	5/8	1/2 - 14
C2606-121212	3/4	3/4 - 14
C2606-141214	7/8	3/4 - 14

C2650 FC - FC - FC - FC Cross

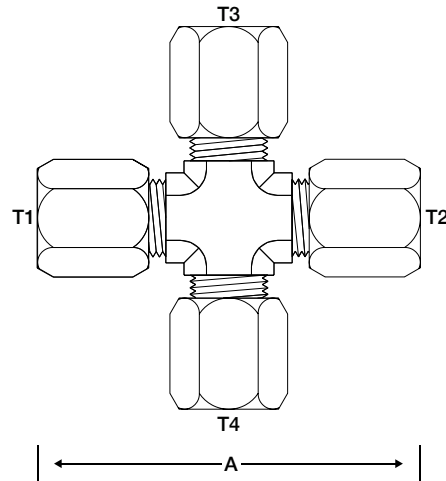

Part Number	T1 / T2	T3 / T4
	FC	FC
C2650-04040404	1/4	1/4
C2650-06060606	3/8	3/8
C2650-08080808	1/2	1/2
C2650-10101010	5/8	5/8
C2650-12121212	3/4	3/4

BECAUSE WE CONTINUALLY EXAMINE WAYS TO IMPROVE OUR PRODUCTS, WE RESERVE THE RIGHT TO ALTER SPECIFICATIONS WITHOUT NOTICE.

C2700 FC - FC Bulkhead

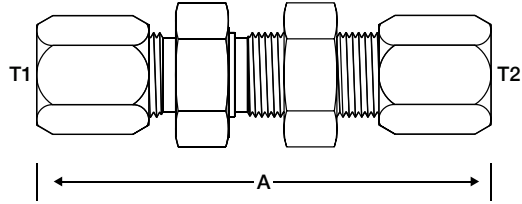

C6400 FC - MORB

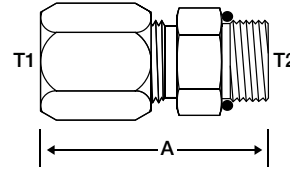

Part Number	T1	T2
	FC	FC
C2700-0404	1/4	1/4
C2700-0606	3/8	3/8
C2700-0808	1/2	1/2
C2700-1010	5/8	5/8
C2700-1212	3/4	3/4
C2700-1616	1	1

Part Number	T1	T2
	FC	MORB
C6400-0404	1/4	7/16 - 20
C6400-0405	1/4	1/2 - 20
C6400-0406	1/4	9/16 - 18
C6400-0505	5/16	1/2 - 20
C6400-0606	3/8	9/16 - 18
C6400-0608	3/8	3/4 - 16
C6400-0806	1/2	9/16 - 18
C6400-0808	1/2	3/4 - 16
C6400-0810	1/2	7/8 - 14
C6400-0812	1/2	1 1/16 - 12
C6400-1010	5/8	7/8 - 14
C6400-1212	3/4	1 1/16 - 12
C6400-1216	3/4	1 5/16 - 12
C6400-1612	1	1 1/16 - 12
C6400-1616	1	1 5/16 - 12
C6400-2020	1 1/4	1 5/8 - 12
C6400-2424	1 1/2	1 7/8 - 12
C6400-3232	2	2 1/2 - 12

Flareless Compression

C6801 FC - MAORB 90°

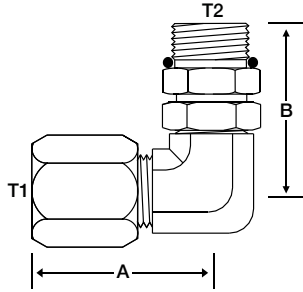

Part Number	T1	T2
	FC	MORB
C6801-0404	1/4	7/16 - 20
C6801-0505	5/16	1/2 - 20
C6801-0606	3/8	9/16 - 18
C6801-0608	3/8	3/4 - 16
C6801-0806	1/2	9/16 - 18
C6801-0808	1/2	3/4 - 16
C6801-0810	1/2	7/8 - 14
C6801-0812	1/2	1 1/16 - 12
C6801-1010	5/8	7/8 - 14
C6801-1208	3/4	3/4 - 16
C6801-1212	3/4	1 1/16 - 12
C6801-1616	1	1 5/16 - 12
C6801-2020	1 1/4	1 5/8 - 12

C6802 FC - MAORB 45°

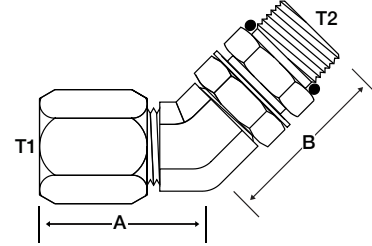

Part Number	T1	T2
	FC	MORB
C6802-0404	1/4	9/16 - 18
C6802-0606	3/8	3/4 - 16
C6802-0808	1/2	3/4 - 16
C6802-1212	3/4	1 1/16 - 12
C6802-1616	1	1 5/16 - 12

C6803 FC - FC MAORB Tee

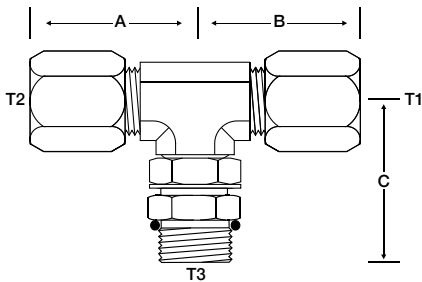

Part Number	T1	T2	T3
			MORB
C6803-040404	1/4	1/4	7/16 - 20
C6803-060606	3/8	3/8	9/16 - 18
C6803-080808	1/2	1/2	3/4 - 16

C6804 MAORB - FC - FC Tee

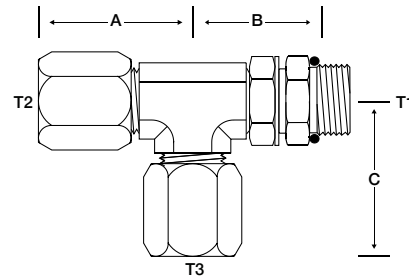

Part Number	T1	T2 / T3
	MORB	FC
C6804-04	7/16 - 20	1/4
C6804-06	9/16 - 18	3/8
C6804-08	3/4 - 16	1/2

BECAUSE WE CONTINUALLY EXAMINE WAYS TO IMPROVE OUR PRODUCTS, WE RESERVE THE RIGHT TO ALTER SPECIFICATIONS WITHOUT NOTICE.