

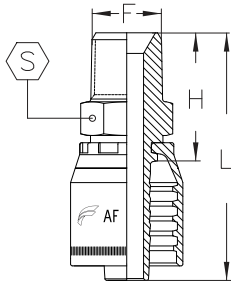



## MP NPT Male



Part Number		F	H		L			
	in		mm	in	mm	in	mm	in
AF04-02MP	1/4	1/8 - 27	21.1	0.83	49.1	1.93	12	1/2
AF04-04MP	1/4	1/4 - 18	27.0	1.06	55.0	2.16	14	9/16
AF04-06MP	1/4	3/8 - 18	28.6	1.12	56.6	2.23	19	3/4
AF04-08MP	1/4	1/2 - 14	34.0	1.34	62.0	2.44	22	7/8
AF06-04MP	3/8	1/4 - 18	27.5	1.08	58.0	2.28	16	5/8
AF06-06MP	3/8	3/8 - 18	28.6	1.12	59.1	2.33	19	3/4
AF06-08MP	3/8	1/2 - 14	34.0	1.34	64.5	2.54	22	7/8
AF08-04MP	1/2	1/4 - 18	30.5	1.20	63.2	2.49	22	7/8
AF08-06MP	1/2	3/8 - 18	30.6	1.20	63.6	2.50	22	7/8
AF08-08MP	1/2	1/2 - 14	35.0	1.38	68.0	2.68	22	7/8
AF08-12MP	1/2	3/4 - 14	36.9	1.45	69.9	2.75	27	1 1/16
AF12-08MP	3/4	1/2 - 14	37.5	1.48	78.0	3.07	27	1 1/16
AF12-12MP	3/4	3/4 - 14	37.9	1.49	78.4	3.09	27	1 1/16
AF12-16MP	3/4	1 - 11 1/2	45.5	1.79	86.0	3.38	35	1 7/16
AF16-12MP	1	3/4 - 14	40.4	1.59	91.4	3.60	32	1 1/4
AF16-16MP	1	1 - 11 1/2	47.0	1.85	98.0	3.86	35	1 7/16
AF16-20MP	1	1 1/4 - 11 1/2	51.1	2.01	102.1	4.02	46	1 13/16

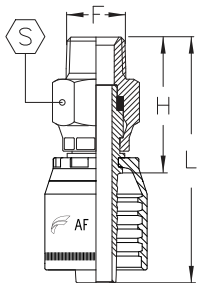

## MPX NPT Male Swivel



Part Number		F	H		L			
	in		mm	in	mm	in	mm	in
AF04-04MPX	1/4	1/4 - 18	41	1.61	69	2.72	17	1 1/16
AF04-06MPX	1/4	3/8 - 18	46	1.81	74	2.91	22	7/8
AF06-04MPX	3/8	1/4 - 18	41	1.61	72	2.83	17	1 1/16
AF06-06MPX	3/8	3/8 - 18	45	1.77	75	2.95	22	7/8
AF06-08MPX	3/8	1/2 - 14	57	2.24	88	3.46	27	1 1/16
AF08-06MPX	1/2	3/8 - 18	46	1.81	79	3.11	22	7/8
AF08-08MPX	1/2	1/2 - 14	56	2.20	89	3.50	27	1 1/16
AF12-12MPX	3/4	3/4 - 14	61	2.40	101	3.98	34	1 3/8
AF16-16MPX	1	1 - 11 1/2	65	2.56	116	4.57	38	1 1/2

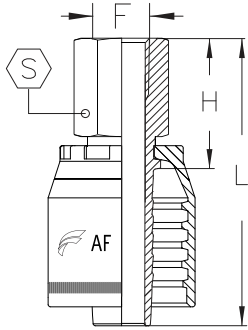

## FP NPT Female Rigid



Part Number		F	H		L			
	in		mm	in	mm	in	mm	in
AF04-02FP	1/4	1/8 - 27	21.5	0.85	49.5	1.95	16	5/8
AF04-04FP	1/4	1/4 - 18	27.1	1.07	55.1	2.17	19	3/4
AF04-06FP	1/4	3/8 - 18	28.4	1.12	56.4	2.22	22	7/8
AF06-04FP	3/8	1/4 - 18	27.1	1.07	57.6	2.27	19	3/4
AF06-06FP	3/8	3/8 - 18	28.4	1.12	58.9	2.32	22	7/8
AF06-08FP	3/8	1/2 - 14	34.5	1.36	65.0	2.56	29	1 1/16
AF08-08FP	1/2	1/2 - 14	35.5	1.40	68.5	2.70	29	1 1/16
AF12-12FP	3/4	3/4 - 14	38.0	1.50	78.5	3.09	32	1 1/4
AF16-16FP	1	1 - 11 1/2	45.8	1.80	96.8	3.81	36	1 1/16

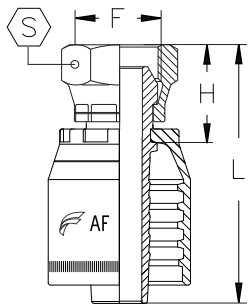

## FPX NPSM Female Swivel (60° Cone Seat)

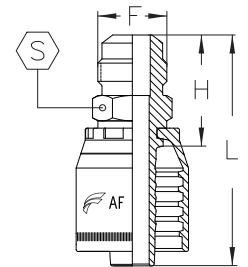

Part Number		F	H		L			
	in		mm	in	mm	in	mm	in
AF04-04FPX	1/4	1/4 - 18	19	0.75	47	1.85	17	1 1/16
AF06-06FPX	3/8	3/8 - 18	21	0.83	51	2.00	22	7/8
AF08-08FPX	1/2	1/2 - 14	23	0.90	56	2.20	25	1
AF12-12FPX	3/4	3/4 - 14	27	1.06	67	2.64	32	1 1/4
AF16-16FPX	1	1 - 11 1/2	30	1.18	81	3.19	38	1 1/2

## MJ JIC 37° Male





Part Number		F	H		L			
	in		mm	in	mm	in	mm	in
AF04-04MJ	1/4	7/16 - 20	25.5	1.00	53.5	2.11	12	1/2
AF04-05MJ	1/4	1/2 - 20	25.5	1.00	53.5	2.11	14	9/16
AF04-06MJ	1/4	9/16 - 18	26.6	1.05	54.6	2.15	15	5/8
AF06-06MJ	3/8	9/16 - 18	26.6	1.05	57.1	2.25	15	5/8
AF06-08MJ	3/8	3/4 - 16	29.7	1.17	60.2	2.37	19	3/4
AF08-08MJ	1/2	3/4 - 16	30.7	1.21	63.7	2.51	19	3/4
AF08-10MJ	1/2	7/8 - 14	35.3	1.39	68.3	2.69	24	1
AF12-12MJ	3/4	1 1/16 - 12	39.9	1.57	80.4	3.16	27	1 1/16
AF16-16MJ	1	1 5/16 - 12	43.6	1.72	94.6	3.72	34	1 3/8

BECAUSE WE CONTINUALLY EXAMINE WAYS TO IMPROVE OUR PRODUCTS, WE RESERVE THE RIGHT TO ALTER SPECIFICATIONS WITHOUT NOTICE.

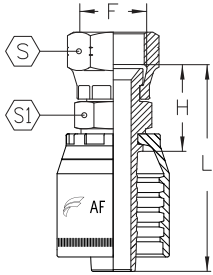

## FJ JIC 37° Female Swivel



Part Number		F	H		L					
	in		mm	in	mm	in	mm	in	mm	in
AF04-04FJ	1/4	7/16 - 20	20.5	0.81	48.5	1.91	14	9/16	14	9/16
AF04-05FJ	1/4	1/2 - 20	21.0	0.83	49.0	1.93	17	1 1/16	14	9/16
AF04-06FJ	1/4	9/16 - 18	22.0	0.87	50.0	1.97	19	3/4	14	9/16
AF06-06FJ	3/8	9/16 - 18	22.5	0.88	53.0	2.09	19	3/4	16	5/8
AF06-08FJ	3/8	3/4 - 16	24.5	0.96	55.0	2.16	22	7/8	19	3/4
AF08-08FJ	1/2	3/4 - 16	25.5	1.00	58.5	2.30	22	7/8	19	3/4
AF08-10FJ	1/2	7/8 - 14	27.5	1.08	60.5	2.38	27	1 1/16	22	7/8
AF08-12FJ	1/2	1 1/16 - 12	30.3	1.19	63.3	2.49	32	1 1/4	25	1
AF12-12FJ	3/4	1 1/16 - 12	31.8	1.25	72.3	2.85	32	1 1/4	27	1 1/16
AF12-16FJ	3/4	1 5/16 - 12	35.5	1.40	76.0	2.99	38	1 1/2	32	1 1/4
AF16-12FJ	1	1 1/16 - 12	34.3	1.35	85.3	3.36	32	1 1/4	32	1 1/4
AF16-16FJ	1	1 5/16 - 12	37.0	1.46	88.0	3.46	38	1 1/2	32	1 1/4

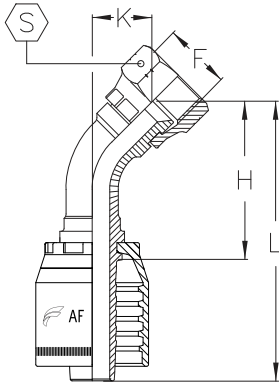

## FJ45 JIC 37° Female Swivel - 45° Elbow

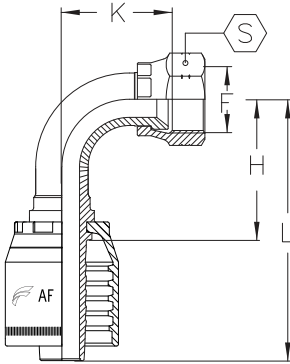

Part Number		F	H		L		K			
	in		mm	in	mm	in	mm	in	mm	in
AF04-04FJ45	1/4	7/16 - 20	31.0	1.22	59.0	2.32	10.0	0.39	14	9/16
AF04-05FJ45	1/4	1/2 - 20	32.0	1.26	60.0	2.36	11.0	0.43	17	11/16
AF04-06FJ45	1/4	9/16 - 18	33.0	1.30	61.0	2.40	12.0	0.47	19	3/4
AF06-06FJ45	3/8	9/16 - 18	35.5	1.40	66.0	2.60	12.0	0.47	19	3/4
AF06-08FJ45	3/8	3/4 - 16	37.5	1.48	68.0	2.68	14.0	0.55	22	7/8
AF08-08FJ45	1/2	3/4 - 16	41.0	1.61	74.0	2.91	14.5	0.57	22	7/8
AF08-10FJ45	1/2	7/8 - 14	43.0	1.69	76.0	2.99	16.0	0.63	27	11/16
AF12-12FJ45	3/4	1 1/16 - 12	57.0	2.24	97.0	3.82	20.0	0.79	32	1 1/4
AF16-16FJ45	1	1 5/16 - 12	72.0	2.83	123.0	4.84	24.0	0.94	38	1 1/2

## FJ90S JIC 37° Female Swivel - 90° Elbow Short Drop





Part Number		F	H		L		K			
	in		mm	in	mm	in	mm	in	mm	in
AF04-04FJ90S	1/4	7/16 - 20	25.5	1.00	53.5	2.11	20	0.79	14	9/16
AF04-05FJ90S	1/4	1/2 - 20	25.5	1.00	53.5	2.11	21	0.83	17	11/16
AF04-06FJ90S	1/4	9/16 - 18	25.5	1.00	53.5	2.11	23	0.90	19	3/4
AF06-06FJ90S	3/8	9/16 - 18	30.0	1.18	60.5	2.38	23	0.90	19	3/4
AF06-08FJ90S	3/8	3/4 - 16	31.0	1.22	61.5	2.42	29	1.14	22	7/8
AF08-08FJ90S	1/2	3/4 - 16	37.0	1.46	70.0	2.75	29	1.14	22	7/8
AF08-10FJ90S	1/2	7/8 - 14	38.0	1.50	71.0	2.79	33	1.30	27	1 1/16
AF12-12FJ90S	3/4	1 1/16 - 12	55.0	2.16	95.0	3.74	43	1.69	32	1 1/4
AF16-16FJ90S	1	1 5/16 - 12	71.0	2.79	122.0	4.80	56	2.20	38	1 1/2

BECAUSE WE CONTINUALLY EXAMINE WAYS TO IMPROVE OUR PRODUCTS, WE RESERVE THE RIGHT TO ALTER SPECIFICATIONS WITHOUT NOTICE.

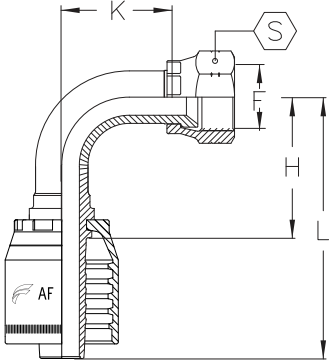

**FJ90M JIC 37° Female Swivel - 90° Elbow Medium Drop**



Part Number		F	H		L		K			
	in		mm	in	mm	in	mm	in	mm	in
AF04-04FJ90M	1/4	7/16 - 20	25.5	1.00	53.5	2.11	26.0	1.02	14	9/16
AF04-05FJ90M	1/4	1/2 - 20	25.5	1.00	53.5	2.11	26.0	1.02	17	11/16
AF04-06FJ90M	1/4	9/16 - 18	25.5	1.00	53.5	2.11	27.0	1.06	19	3/4
AF06-06FJ90M	3/8	9/16 - 18	31.0	1.22	61.5	2.42	33.0	1.30	19	3/4
AF06-08FJ90M	3/8	3/4 - 16	31.0	1.22	61.5	2.42	33.0	1.30	22	7/8
AF08-08FJ90M	1/2	3/4 - 16	37.0	1.46	70.0	2.75	39.0	1.53	22	7/8
AF08-10FJ90M	1/2	7/8 - 14	37.0	1.46	70.0	2.75	40.0	1.57	27	1 1/16
AF12-12FJ90M	3/4	1 1/16 - 12	55.0	2.16	95.0	3.74	53.0	2.09	32	1 1/4
AF16-16FJ90M	1	1 5/16 - 12	71.0	2.79	122.0	4.80	70.0	2.75	38	1 1/2

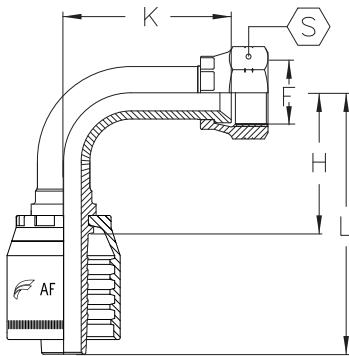

**FJ90L JIC 37° Female Swivel - 90° Elbow Long Drop**



Part Number		F	H		L		K			
	in		mm	in	mm	in	mm	in	mm	in
AF04-04FJ90L	1/4	7/16 - 20	25.5	1.00	53.5	2.11	46.0	1.81	14	9/16
AF04-05FJ90L	1/4	1/2 - 20	25.5	1.00	53.5	2.11	46.0	1.81	17	11/16
AF04-06FJ90L	1/4	9/16 - 18	25.5	1.00	53.5	2.11	54.0	2.12	19	3/4
AF06-06FJ90L	3/8	9/16 - 18	31.0	1.22	61.5	2.42	54.0	2.12	19	3/4
AF06-08FJ90L	3/8	3/4 - 16	31.0	1.22	61.5	2.42	64.0	2.52	22	7/8
AF08-08FJ90L	1/2	3/4 - 16	38.0	1.50	71.0	2.79	64.0	2.52	22	7/8
AF12-12FJ90L	3/4	1 1/16 - 12	55.0	2.16	95.0	3.74	96.0	3.78	32	1 1/4
AF16-16FJ90L	1	1 5/16 - 12	71.0	2.79	122.0	4.80	114.0	4.49	38	1 1/2

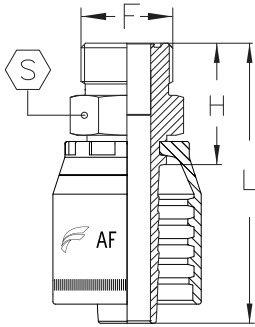

## MF ORFS Male

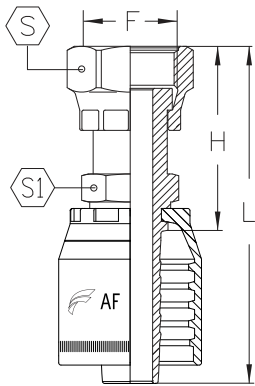

Part Number		F	H		L			
	in		mm	in	mm	in	mm	in
AF04-04MF	1/4	9/16 - 18	23.5	0.92	51.5	2.02	17	1 1/16
AF04-06MF	1/4	1 1/16 - 16	25.5	1.00	53.5	2.10	19	3/4
AF06-06MF	3/8	1 1/16 - 16	25.5	1.00	56.0	2.20	19	3/4
AF06-08MF	3/8	1 3/16 - 16	28.5	1.12	59.0	2.32	22	7/8
AF08-08MF	1/2	1 3/16 - 16	29.5	1.16	62.5	2.46	22	7/8
AF08-10MF	1/2	1 - 14	34.0	1.33	67.0	2.63	27	1 1/16
AF12-12MF	3/4	1 3/16 - 12	38.0	1.49	78.5	3.09	32	1 1/4
AF16-16MF	1	1 7/16 - 12	44.0	1.73	95.0	3.74	41	1 5/8

## FF ORFS Female Swivel





Part Number		F	H		L					
	in		mm	in	mm	in	mm	in	mm	in
AF04-04FF	1/4	9/16 - 18	26.5	1.04	54.5	2.14	17	1 1/16	14	9/16
AF04-06FF	1/4	1 1/16 - 16	28.5	1.12	56.5	2.22	22	7/8	16	5/8
AF06-06FF	3/8	1 1/16 - 16	28.5	1.12	59.0	2.32	22	7/8	16	5/8
AF06-08FF	3/8	1 3/16 - 16	32.5	1.27	63.0	2.48	24	1	19	3/4
AF08-08FF	1/2	1 3/16 - 16	33.5	1.31	66.5	2.61	24	1	19	3/4
AF08-10FF	1/2	1 - 14	39.5	1.55	72.5	2.85	30	1 3/16	24	1
AF12-12FF	3/4	1 3/16 - 12	44.5	1.75	85.0	3.34	36	1 7/16	27	1 1/16
AF16-16FF	1	1 7/16 - 12	49.0	1.92	100.0	3.93	41	1 5/8	36	1 1/16

BECAUSE WE CONTINUALLY EXAMINE WAYS TO IMPROVE OUR PRODUCTS, WE RESERVE THE RIGHT TO ALTER SPECIFICATIONS WITHOUT NOTICE.

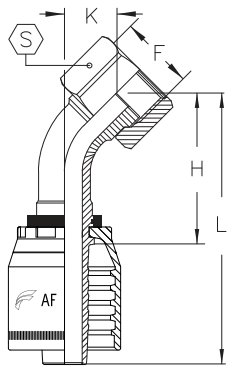

**FF45 ORFS Female Swivel - 45° Elbow**



Part Number		F	H		L		K			
	in		mm	in	mm	in	mm	in	mm	in
AF04-04FF45	1/4	9/16 - 18	32.5	1.27	60.5	2.38	10.5	0.41	17	1 1/16
AF04-06FF45	1/4	1 1/16 - 16	34.5	1.35	62.5	2.46	12.5	0.49	22	7/8
AF06-08FF45	3/8	1 3/16 - 16	38.5	1.51	69.0	2.71	15.0	0.59	24	1
AF08-08FF45	1/2	1 3/16 - 16	42.5	1.67	75.5	2.97	15.5	0.61	24	1
AF08-10FF45	1/2	1 - 14	45.0	1.77	78.0	3.07	17.5	0.68	30	1 3/16
AF12-12FF45	3/4	1 3/16 - 12	58.0	2.28	99.0	3.89	21.0	0.82	36	1 7/16
AF16-16FF45	1	1 7/16 - 12	73.0	2.87	124.0	4.88	24.0	0.94	41	1 5/8

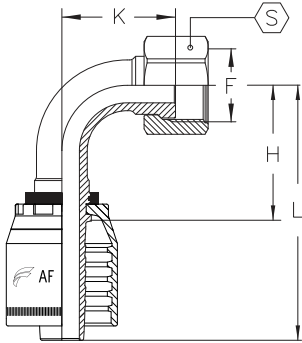

**FF90S ORFS Female Swivel - 90° Elbow Short Drop**



Part Number		F	H		L		K			
	in		mm	in	mm	in	mm	in	mm	in
AF04-04FF90S	1/4	9/16 - 18	27.0	1.06	55.0	2.17	21.0	0.83	17	1 1/16
AF04-06FF90S	1/4	1 1/16 - 16	27.0	1.06	55.0	2.17	24.0	0.94	22	7/8
AF06-06FF90S	3/8	1 1/16 - 16	31.5	1.24	62.0	2.44	24.5	0.96	22	7/8
AF06-08FF90S	3/8	1 3/16 - 16	34.0	1.34	61.0	2.40	30.0	1.18	24	1
AF08-08FF90S	1/2	1 3/16 - 16	39.0	1.54	72.0	2.83	31.0	1.22	24	1
AF08-10FF90S	1/2	1 - 14	39.0	1.54	72.0	2.83	34.0	1.34	30	1 3/16
AF12-12FF90S	3/4	1 3/16 - 12	55.0	2.17	95.0	3.74	45.0	1.77	36	1 7/16
AF16-16FF90S	1	1 7/16 - 12	71.0	2.79	122.0	4.80	55.0	2.17	41	1 5/8

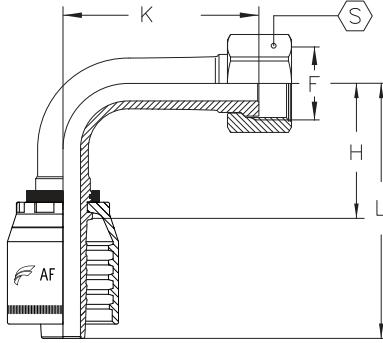

## FF90L ORFS Female Swivel - 90° Elbow Long Drop

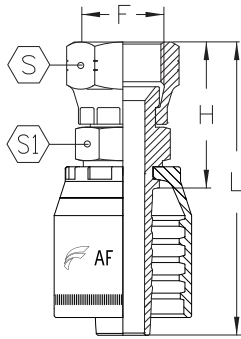

Part Number		F	H		L		K			
	in		mm	in	mm	in	mm	in	mm	in
AF04-04FF90L	1/4	9/16 - 18	29.0	1.14	57.0	2.24	46.0	1.81	17	11/16
AF04-06FF90L	1/4	11/16 - 16	27.0	1.06	55.0	2.16	54.0	2.12	22	7/8
AF06-06FF90L	3/8	11/16 - 16	34.0	1.33	64.5	2.53	54.0	2.12	22	7/8
AF06-08FF90L	3/8	13/16 - 16	34.0	1.33	64.5	2.53	64.0	2.51	24	1
AF08-08FF90L	1/2	13/16 - 16	39.0	1.53	72.0	2.83	64.0	2.51	24	1
AF08-10FF90L	1/2	1 - 14	39.0	1.53	72.0	2.83	70.0	2.75	30	1 3/16
AF12-12FF90L	3/4	1 3/16 - 12	55.0	2.17	95.0	3.74	96.0	3.77	36	1 7/16
AF16-16FF90L	1	1 7/16 - 12	71.0	2.79	122.0	4.80	114.0	4.48	41	1 5/8

## FJIS JIS Female Swivel (Toyota)





Part Number		F	H		L		K			
	in		mm	in	mm	in	mm	in	mm	in
AF04-04FJIS	1/4	1/4 - 19	24	0.94	52.0	2.05	19.0	3/4	14	9/16
AF06-06FJIS	3/8	3/8 - 19	26	1.02	57.0	2.24	22.0	7/8	17	11/16
AF08-08FJIS	1/2	1/2 - 14	30	1.18	63.0	2.48	27.0	1 1/16	22	7/8
AF12-12FJIS	3/4	3/4 - 14	36	1.42	76.0	2.99	32.0	1 1/4	27	1 1/16
AF16-16FJIS	1	1 - 11	40	1.57	91.0	3.58	41.0	1 5/8	32	1 1/4



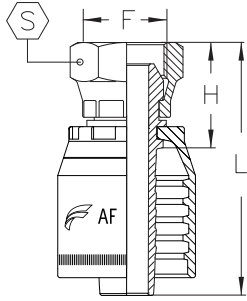

**FBSPP BSPF Female Swivel**



Part Number		F	H		L			
	in		mm	in	mm	in	mm	in
AF04-02FBSPP	1/4	1/8 - 28	17.0	0.67	45.0	1.77	14	9/16
AF04-04FBSPP	1/4	1/4 - 19	19.0	0.75	47.0	1.85	19	3/4
AF04-06FBSPP	1/4	3/8 - 19	22.0	0.87	50.0	1.97	22	7/8
AF06-06FBSPP	3/8	3/8 - 19	21.0	0.83	51.0	2.01	22	7/8
AF06-08FBSPP	3/8	1/2 - 14	23.0	0.90	54.0	2.12	27	1 1/16
AF08-08FBSPP	1/2	1/2 - 14	23.0	0.90	56.0	2.20	27	1 1/16
AF08-10FBSPP	1/2	5/8 - 14	24.0	0.94	57.0	2.24	30	1 3/16
AF12-12FBSPP	3/4	3/4 - 14	27.0	1.06	67.0	2.64	32	1 1/4
AF16-16FBSPP	1	1 - 11	30.0	1.18	81.0	3.19	41	1 5/8

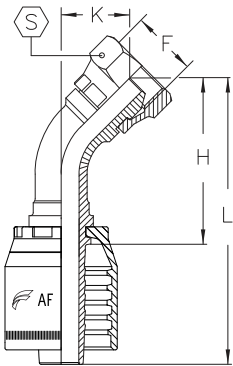

**FBSPP45 BSPF Female Swivel - 45° Elbow**

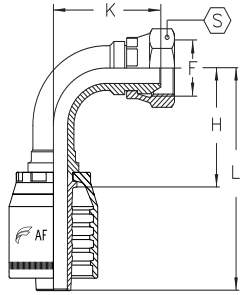

Part Number		F	H		L		K			
	in		mm	in	mm	in	mm	in	mm	in
AF04-02FBSPP45	1/4	1/8 - 28	36.0	1.42	64.0	2.52	16.0	0.63	14	9/16
AF04-04FBSPP45	1/4	1/4 - 19	37.0	1.46	65.0	2.56	16.0	0.63	19	3/4
AF04-06FBSPP45	1/4	3/8 - 19	40.0	1.57	68.0	2.68	19.0	0.75	22	7/8
AF06-06FBSPP45	3/8	3/8 - 19	42.0	1.65	73.0	2.87	19.0	0.75	22	7/8
AF06-08FBSPP45	3/8	1/2 - 14	44.0	1.73	75.0	2.95	21.0	0.83	27	1 1/16
AF08-08FBSPP45	1/2	1/2 - 14	49.0	1.93	82.0	3.23	22.0	0.87	27	1 1/16
AF08-10FBSPP45	1/2	5/8 - 14	49.0	1.93	82.0	3.23	22.0	0.87	30	1 3/16
AF12-12FBSPP45	3/4	3/4 - 14	66.0	2.60	106.0	4.17	28.0	1.10	32	1 1/4
AF16-16FBSPP45	1	1 - 11	84.0	3.31	135.0	5.31	36.0	1.42	41	1 5/8

## FBSP90 BSPF Female Swivel - 90° Elbow





Part Number		F	H		L		K			
	in		mm	in	mm	in	mm	in	mm	in
AF04-02FBSP90	1/4	1/8 - 28	26.0	1.02	54.0	2.12	28.0	1.10	14	9/16
AF04-04FBSP90	1/4	1/4 - 19	26.0	1.02	54.0	2.12	28.0	1.10	19	3/4
AF04-06FBSP90	1/4	3/8 - 19	26.0	1.02	54.0	2.12	32.0	1.26	22	7/8
AF06-06FBSP90	3/8	3/8 - 19	31.0	1.22	61.0	2.40	35.0	1.38	22	7/8
AF06-08FBSP90	3/8	1/2 - 14	31.0	1.22	61.0	2.40	38.0	1.50	27	1 1/16
AF08-08FBSP90	1/2	1/2 - 14	37.0	1.46	70.0	2.75	42.0	1.65	27	1 1/16
AF08-10FBSP90	1/2	5/8 - 14	37.0	1.46	70.0	2.75	43.0	1.69	30	1 3/16
AF12-12FBSP90	3/4	3/4 - 14	54.0	2.12	95.0	3.74	56.0	2.20	32	1 1/4
AF16-16FBSP90	1	1 - 11	70.0	2.76	121.0	4.76	72.0	2.83	41	1 5/8

2

AF Series - Industrial Hose

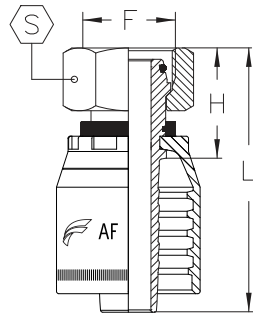
## FML Metric 24° Female Light - (DKOL)



Part Number		F	Tube	H		L		S	
	in			mm	in	mm	in	mm	in
AF04-12FML	1/4	M12 x 1.5	L6	23.0	0.90	51.0	2.01	17	1 1/16
AF04-14FML	1/4	M14 x 1.5	L8	22.0	0.87	50.0	1.97	17	1 1/16
AF04-16FML	1/4	M16 x 1.5	L10	24.0	0.94	52.0	2.05	19	3/4
AF04-18FML	1/4	M18 x 1.5	L12	24.0	0.94	52.0	2.05	22	7/8
AF06-16FML	3/8	M16 x 1.5	L10	23.0	0.90	54.0	2.12	19	3/4
AF06-18FML	3/8	M18 x 1.5	L12	24.0	0.94	54.0	2.12	22	7/8
AF06-22FML	3/8	M22 x 1.5	L15	24.0	0.94	54.0	2.12	27	1 1/16
AF08-22FML	1/2	M22 x 1.5	L15	24.0	0.94	57.0	2.24	27	1 1/16
AF08-26FML	1/2	M26 x 1.5	L18	26.0	1.02	59.0	2.32	32	1 1/4
AF12-30FML	3/4	M30 x 2.0	L22	31.0	1.22	71.0	2.79	36	1 7/16
AF16-36FML	1	M36 x 2.0	L28	32.0	1.26	83.0	3.27	41	1 5/8

BECAUSE WE CONTINUALLY EXAMINE WAYS TO IMPROVE OUR PRODUCTS, WE RESERVE THE RIGHT TO ALTER SPECIFICATIONS WITHOUT NOTICE.